

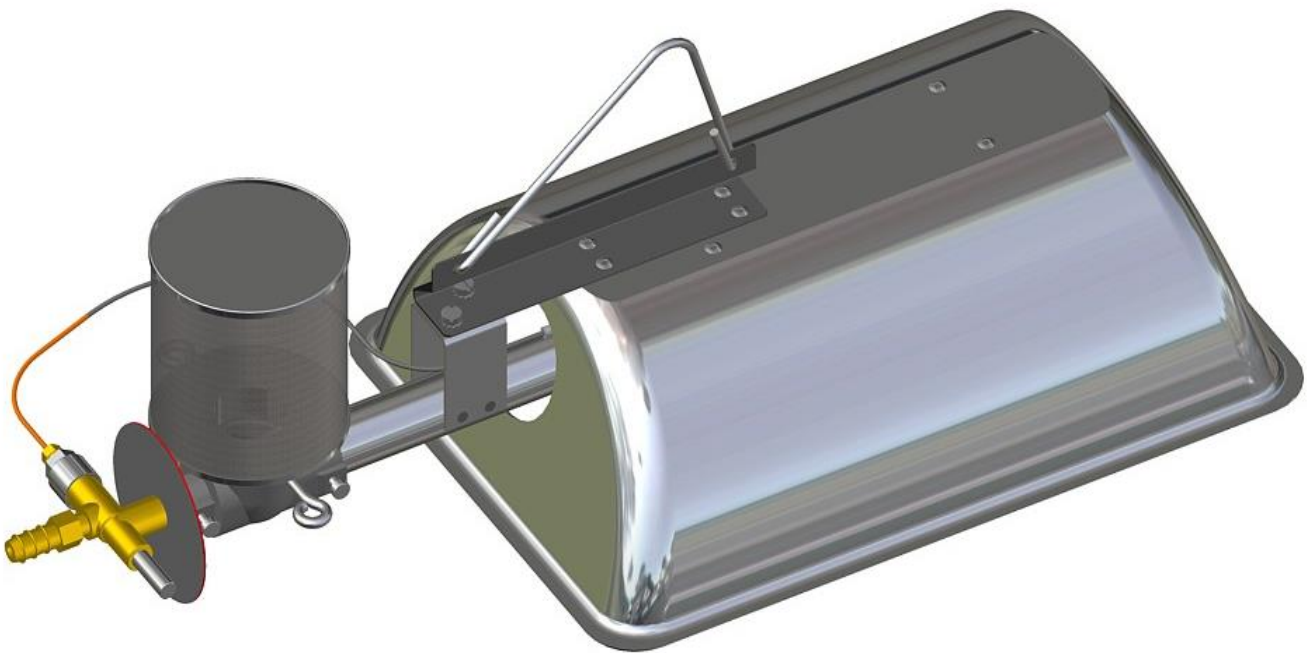

Infrared Heater M5



A

Infrared Heater M5

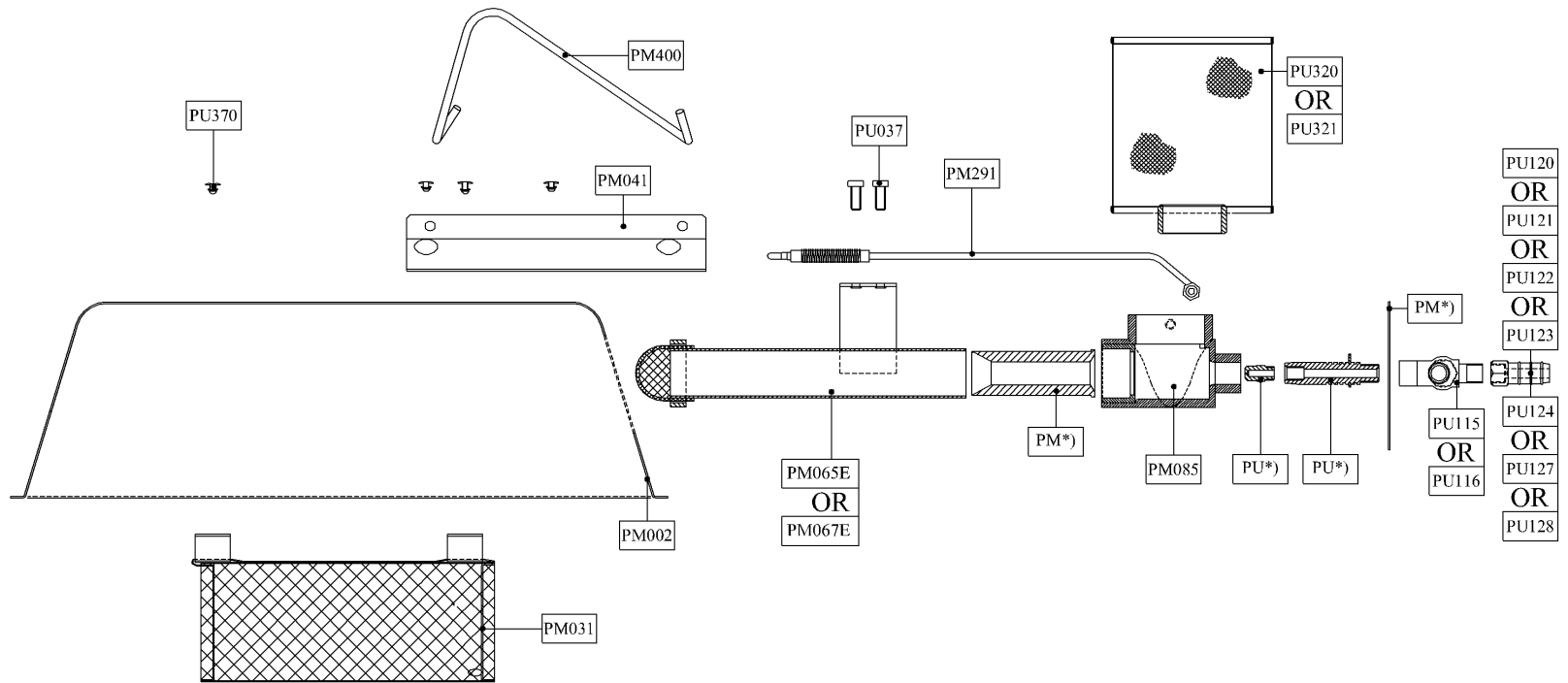

B

Infrared Heater M5

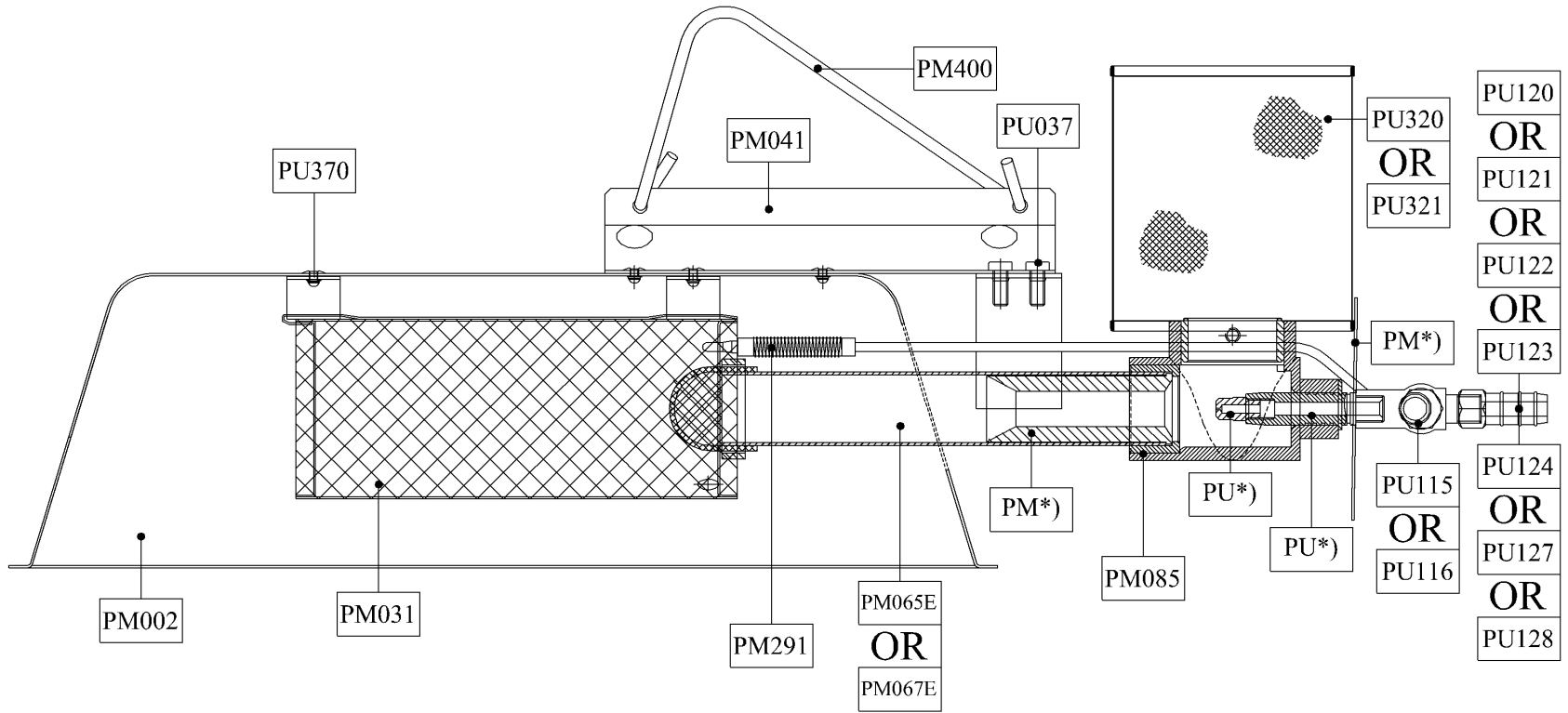









Parts List M5



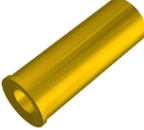

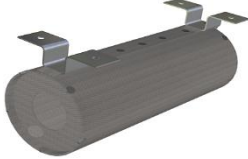
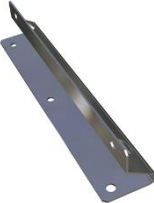





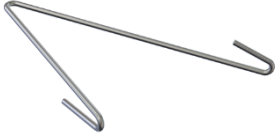



Part:	#	Description:	Old Reference:
PU*)	1	Jet S/M, depends on gas type and pressure	27
PU*)	1	Jet Holder S/M, depends on gas type and pressure	28
PM*)	1	Marking Plate M8, depends on gas type and pressure	40
PM*)	1	Venturi, depends on gas type and pressure	26
PM002	1	Reflector M5/ M8	21
PM031	1	Round Burner M5 with extra hole for tip thermocouple	22
PM041	1	Suspension Frame M5/ M8	23
PM065E** Or PM067E**	1	Burner pipe M5 Round** without sensor strip Burner pipe M5 Flat** without sensor strip	24
PM085	1	T-piece special (for M-types) Incl. 2x PU036 – Screw M5x10 Incl. 1x PU038 – Thumb Screw T-piece M5x30x8	25
PM291	1	Thermocouple L=330mm	29
PM400	1	Suspension Hook M5/ M8	37
PU037	2	Screw S.S. M5x10 with spring ring	33
PU115 Or PU116	1	Safety Device without Hose Socket Incl. PU117 – Interior Coil Small Safety Device with Hose Socket Incl. PU117 – Interior Coil Small	30
PU120 Or PU121 Or PU122 Or PU123 Or PU124 Or PU127 Or PU128	1	Hose Socket 1/8"F 9mm Hose Socket 1/8"F 11mm Hose Socket 1/8"F 8mm smooth Bushing 1/8"F*3/8"M Bushing 1/8"F*1/2"M Special Connection Japan CGA Connection	31
PU320 Or PU321	1	Stainless Steel Filter standard M/S Filter M/S Heavy Duty	32
PU370	6	Rivet, stainless Ø4	36

NOTES:

PU*) & PM*): Depends on gas type and pressure.
****):** This also depends on gas type and pressure!

Infrared Heater M5 Position Numbers

PU*)	Jet S/M, depends on gas type and pressure	
PU*)	Jet Holder S/M, depends on gas type and pressure	
PM*)	Marking Plate M5, depends on gas type and pressure	
PM*)	Venturi, depends on gas type and pressure	
PM002	Reflector M5/ M8	
PM031	Round Burner M5 with extra hole for tip thermocouple	
PM041	Suspension Frame M5/ M8	
PM065E** Or	Burner pipe M5 Round** without sensor strip	
PM067E**	Burner pipe M5 Flat** without sensor strip	
PM085	T-piece special (for M-types) Incl. 2x PU036 – Screw M5x10 Incl. 1x PU038 – Thumb Screw T-piece M5x30x8	
PM291	Thermocouple L=330mm	

PM400	Suspension Hook M5/ M8	
PU037	Screw S.S. M5x10 with spring ring	
PU115 Or	Safety Device without Hose Socket Incl. PU117 - Interior Coil Small	
PU116	Safety Device with Hose Socket Incl. PU117 - Interior Coil Small	
PU117	Magnetic Coil Small	
PU120 Or	Hose Socket 1/8"F 9mm	
PU121 Or	Hose Socket 1/8"F 11mm	
PU122 Or	Hose Socket 1/8"F 8mm smooth	
PU123 Or	Bushing 1/8"F*3/8"M	
PU124 Or	Bushing 1/8"F*1/2"M	
PU127 Or	Special Connection Japan	
PU128	CGA Connection	
PU320 Or	Stainless Steel Filter standard M/S	
PU321	Filter M/S Heavy Duty	
PU370	Rivet, stainless Ø4	



Infrared Heater M8

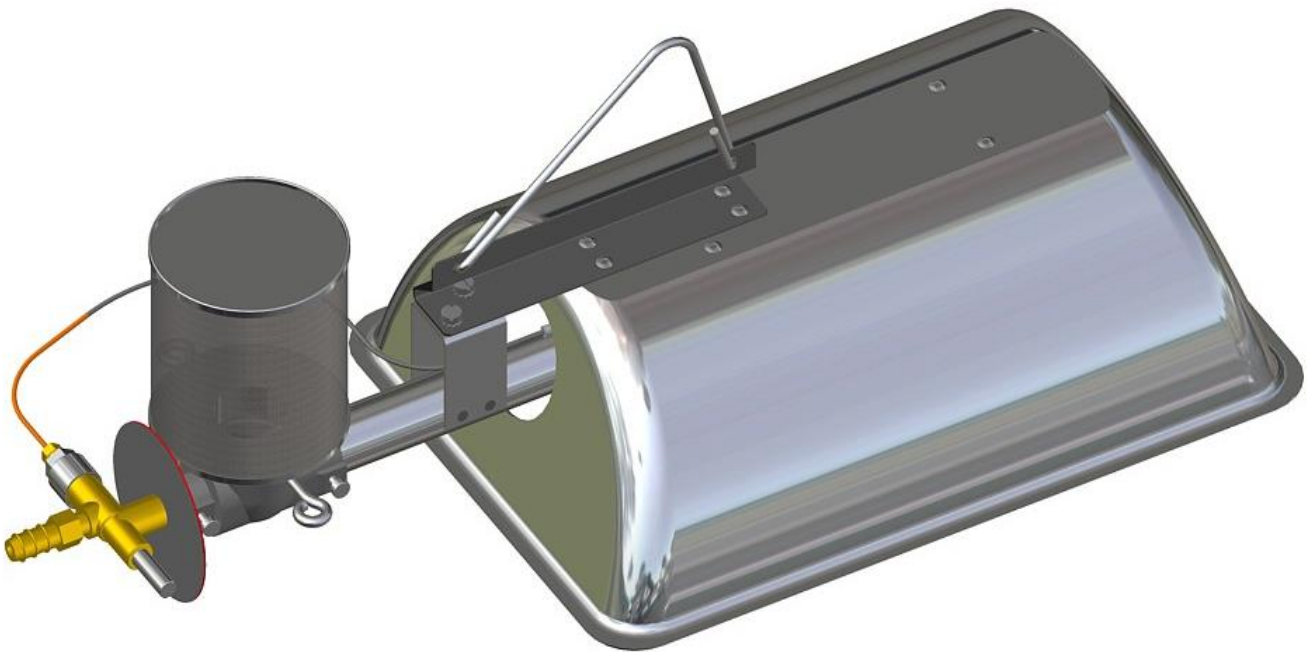

A

Infrared Heater M8

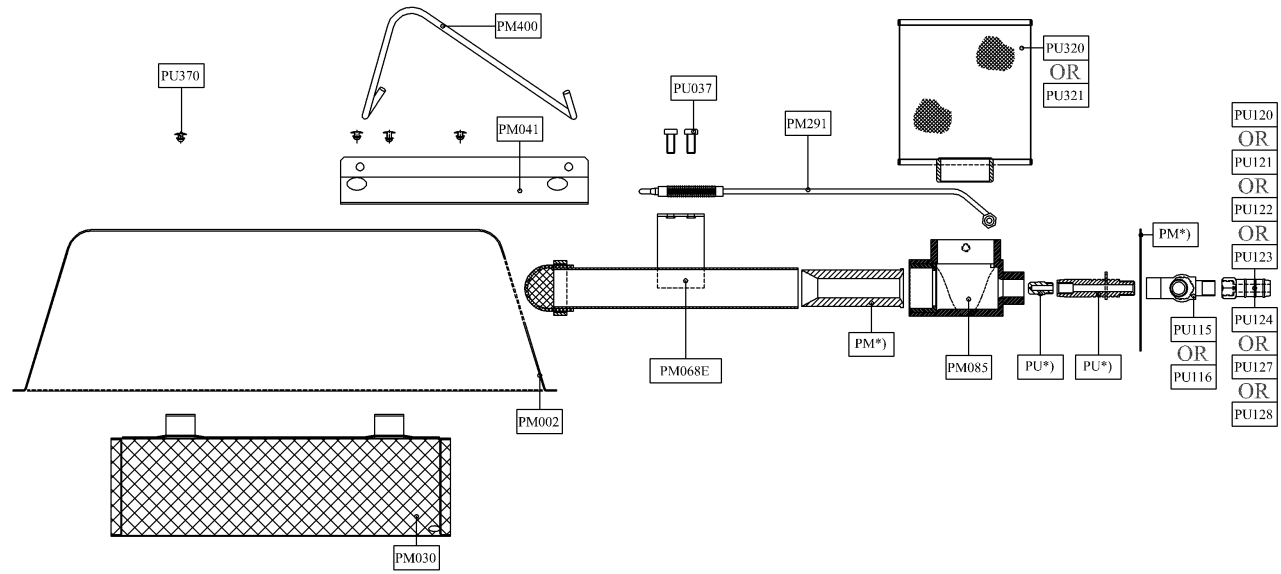

B Infrared Heater M8

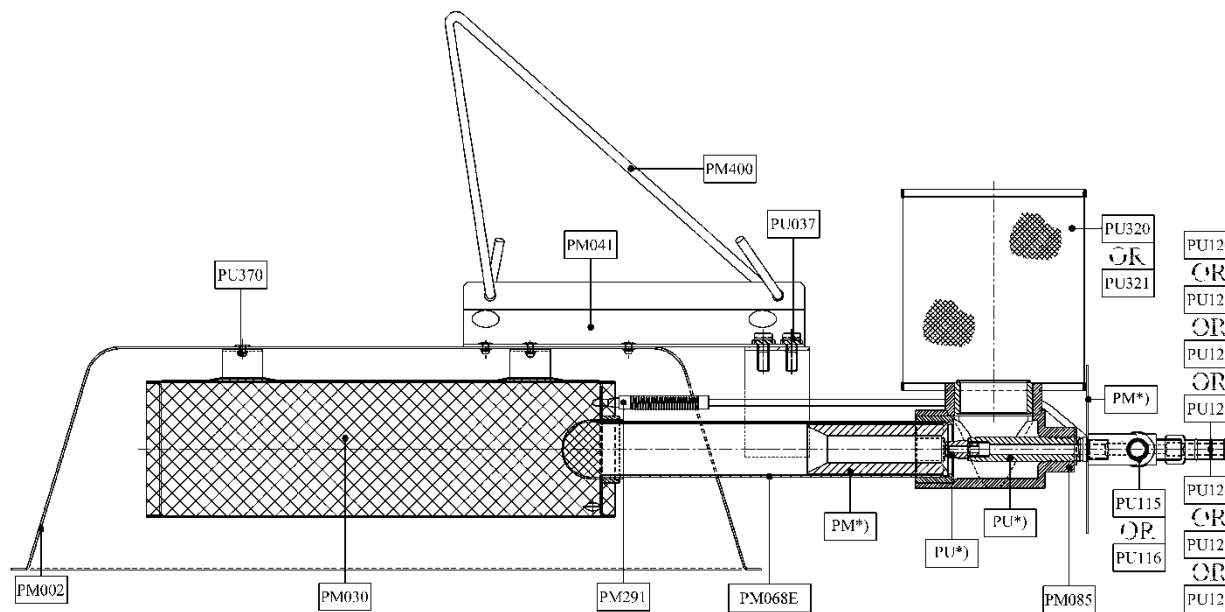

Parts List M8









Part:	#	Description:	Old Reference:
PU*)	1	Jet S/M, depends on gas type and pressure	27
PU*)	1	Jet Holder S/M, depends on gas type and pressure	28
PM*)	1	Marking Plate M8, depends on gas type and pressure	40
PM*)	1	Venturi, depends on gas type and pressure	26
PM002	1	Reflector M5/ M8	21
PM030	1	Round Burner M8 with extra hole for tip thermocouple	22
PM041	1	Suspension Frame M5/ M8	23
PM068E	1	Burner pipe M8 Round without sensor strip	24
PM085	1	T-piece special (for M-types) Incl. 2x PU036 – Screw M5x10 Incl. 1x PU038 – Thumb Screw T-piece M5x30x8	25
PM291	1	Thermocouple L=330mm	29
PM400	1	Suspension Hook M5/ M8	37
PU037	2	Screw S.S. M5x10 with spring ring	33
PU115	1	Safety Device without Hose Socket Incl. PU117 – Interior Coil Small	30
Or			
PU116		Safety Device with Hose Socket Incl. PU117 – Interior Coil Small	
PU120	1	Hose Socket 1/8"F 9mm	31
Or			
PU121		Hose Socket 1/8"F 11mm	
Or			
PU122		Hose Socket 1/8"F 8mm smooth	
Or			
PU123		Bushing 1/8"F*3/8"M	
Or			
PU124		Bushing 1/8"F*1/2"M	
Or			
PU127		Special Connection Japan	
Or			
PU128		CGA Connection	
PU320	1	Stainless Steel Filter standard M/S	32
Or			
PU321		Filter M/S Heavy Duty	
PU370	6	Rivet, stainless Ø4	36



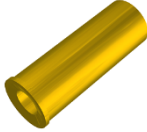

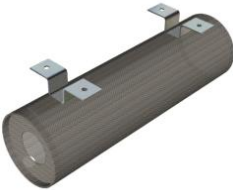



NOTES:

PU*) & PM*): Depends on gas type and pressure.

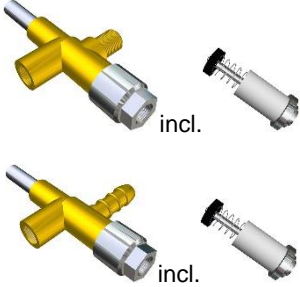
**): This also depends on gas type and pressure!

Infrared Heater M8 Position Numbers

PU*)	Jet S/M, depends on gas type and pressure	
PU*)	Jet Holder S/M, depends on gas type and pressure	
PM*)	Marking Plate M8, depends on gas type and pressure	
PM*)	Venturi, depends on gas type and pressure	
PM002	Reflector M5/ M8	
PM030	Round Burner M8 with extra hole for tip thermocouple	
PM041	Suspension Frame M5/ M8	
PM068E	Burner pipe M8 Round without Sensor strip	
PM085	T-piece special (for M-types) Incl. 2x PU036 – Screw M5x10 Incl. 1x PU038 – Thumb Screw T-piece M5x30x8	
PM291	Thermocouple L=330mm	

PM400	Suspension Hook M5/ M8	
PU037	Screw S.S. M5x10 with spring ring	
PU115 Or PU116	Safety Device without Hose Socket Incl. PU117 - Interior Coil Small Safety Device with Hose Socket Incl. PU117 - Interior Coil Small	
PU117	Magnetic Coil Small	
PU120 Or PU121 Or PU122	Hose Socket 1/8"F 9mm Hose Socket 1/8"F 11mm Hose Socket 1/8"F 8mm smooth	
PU123 Or PU124	Bushing 1/8"F*3/8"M Bushing 1/8"F*1/2"M	
PU127 Or PU128	Special Connection Japan CGA Connection	
PU320 Or PU321	Stainless Steel Filter standard M/S Filter M/S Heavy Duty	
PU370	Rivet, stainless Ø4	

